

Olfactory Detection System for GC or GC-MS

PHASER Pro



What is GC/O System?

The human nose is an incredible detector for aroma/malodor components. GC/O (Gas Chromatography/Olfactometry) is a technique used for detection of odor compounds by the human nose. Combining GC (instrumental analysis) and nasal (sensory evaluation) information is important in the analysis of aromas and odors in foods, beverages, flavors and fragrances.

In the GC/O, the outlet of the GC column is split, one end is connected to a detector (FID or MS) for compound analysis, the other end is connected to a nose cone used to sniff and identify the compounds.

The GC/O covers a wide scope of applications, in fragrances, foods, pharmaceuticals, packaging, and chemical industries.



System channel diagram

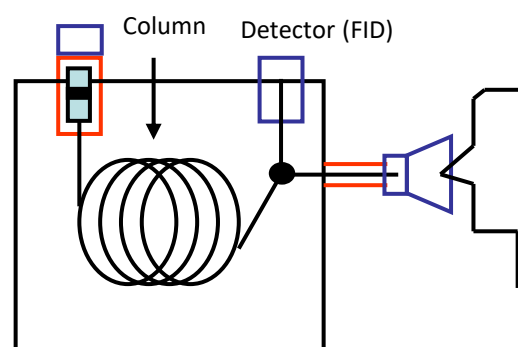

At the column outlet, the compounds are split to detector and sniffer, using nose to identify the compounds that were separated on the column.

PHASER Pro Sniffing Port

The PHASER Pro is the latest edition of the sniffing port. A temperature-programmable transfer line is introduced in this instrument, that can be programmed as the GC oven. This results in a stable split ratio (sniffing flow rate/detector flow rate). Heat stress at the nose and thermal degradation of the compounds are prevented, making it possible to perform olfactory detection with higher accuracy and sensitivity.

The transfer line has been designed in such a way that there are no cold spots along the line. This allows high precision evaluation of odors. High-boiling or adsorptive compounds are not trapped inside the transfer line. The target compounds are obtained without loss.

- Transfer line temperature maximum of 300 °C
- Transfer line without cold spots
- Efficient detection of high boiling components
- Air purge humidifier protects nasal mucosa against drying
- Compatible with any GC make
- Reduced nasal heat stress
- Reduced thermal degradation of analyte



Nose Cone

Specifications (Sniffing Port PHASER Pro)



PHASER Pro

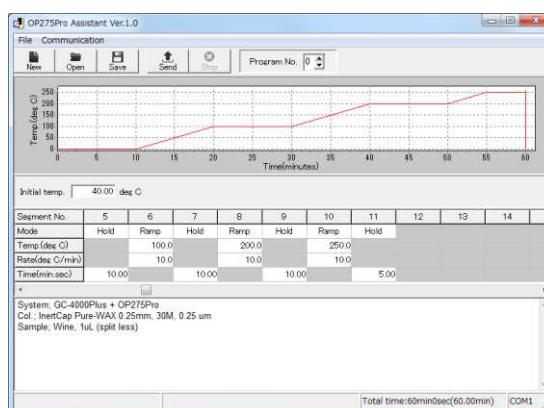

Temperature program is set via dedicated control software, PHASER Pro Assistant.

Model	PHASER Pro
Temp. control method	SSR zero cross PID control
Operation temp. range	0-300 °C (0.1 °C step)
Temp. control range	Room temperature +20 °C to 300 °C
Temp. gradient setting	0~20 °C/min, (0.1 °C/min step)
Number of temp. programs	8
Number of segment	Max. 32
Segment setting time	0 min 0 sec ~ 99 min 59 sec
Auxiliary gas	He, N2
Flow control device	Mass flow control valve
Inlet port	1/8" tube connection
Outlet port	1/16" tube connection
Moist air	Clean air
Flow control device	Speed control valve
Inlet port	1/8"-1/8" tube connection
Outlet port	1/8"-1/8" tube one-touch connection
Inputs and outputs	USB port (for temperature setting software) START IN
Supplied pressure range	0.1 ~ 0.6 MPa
Splitter connection	Deactivated capillary tube connection (male nut type)
Size	Controller: 96 (W) X 230 (D) X 300 (H) mm (excluding protrusions) Transfer line: Outer dia. 35 mm X length 1000 mm
Weight	Controller: Approx. 4 kg Transfer line: Approx. 1.8 kg
Temp./Humidity Range	5 ~ 35 °C / 10 ~ 85 %, no condensing water
Power	200 to 240V AC, 50/60 Hz/ Max.230VA

Comparison of GC/O for Programmed and Isocratic Temperature

Analysis of Sotolon

Conditions

System : GC-FID
 Column : InertCap 5, 0.25 mm I.D. × 30 m, df = 0.25 μm
 Col. Temp. : 50 °C (1 min) - 15 °C/min - 250 °C
 Carrier Gas : He, 200 kPa
 Injection : Splitless
 Injection Vol. : 1 μL
 Sample : Sotolon 10 ppm in EtOH

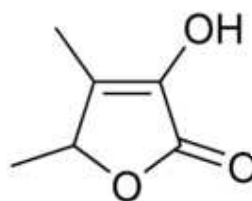

Sotolon
 Boiling point : 184 °C

Transfer line temperature at peak detection : 133 °C
 Transfer line temperature: 50 °C (1 min) - 15 °C/min - 250 °C

Transfer line temperature at peak detection : 250 °C
 Transfer line temperature: isocratic

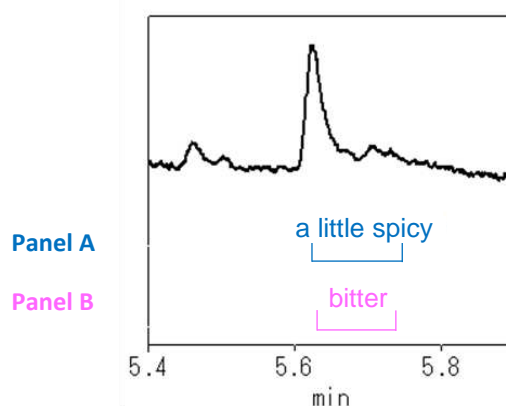
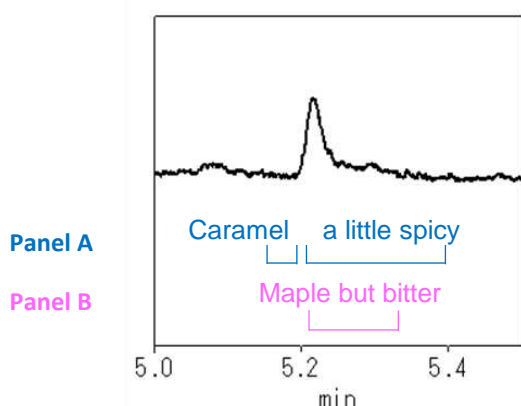

Two panels performed sensory tests at the same conditions and for the same samples

When the transfer line is isothermal at 250°C, "spicy" or "bitter" is only perceived. However, applying programmed temperature, the panel was able to perceive changes of odor; from "sweet" to "caramel" and "bitter" to "maple". The odor with the programmed temperature function was perceived over an increased period of time.

Analysis of Fatty Alcohol

Compound	Temp. *	Panel A		Panel B	
		Transfer line 250 °C, iso	TL temp. programmed	Transfer line 250 °C, iso	TL temp. programmed
1-Butanol	62 °C	Oil	Cheese to Oil	N.D.	Cheese
1-Pentanol	70 °C	Oil	Oil, Offensive	N.D.	N.D.
1-Hexanol	82 °C	Hexanol	Grassy Hexanol	Grassy	Greenly
1-Heptanol	97 °C	Oil	Grassy	Oily	Sweet

*:Temperature of the transfer line when peak was detected (temperature increase of the transfer line only)

Two panels performed sensory tests at the same conditions and for the same samples

When using the programmed temperature function, odors changes due to concentration changes were perceived according to the rise of the peak. For example, 1-Butanol was perceived as Oil when using an isocratic program. While it was perceived as cheese to oil when using a temperature program.

Olfactory Voicegram Interface Kit

The Olfactory Voicegram Interface Kit is dedicated software for recording and analyzing odor information. Because the odor often contains multiple compounds and some peaks may be adjacent, retention time and information about the quality and intensity of the odor are important. In the Olfactory Voicegram, clicks, audio recordings and manipulations of Aroma Pallet add valuable information to the chromatogram.

● Analysis screen

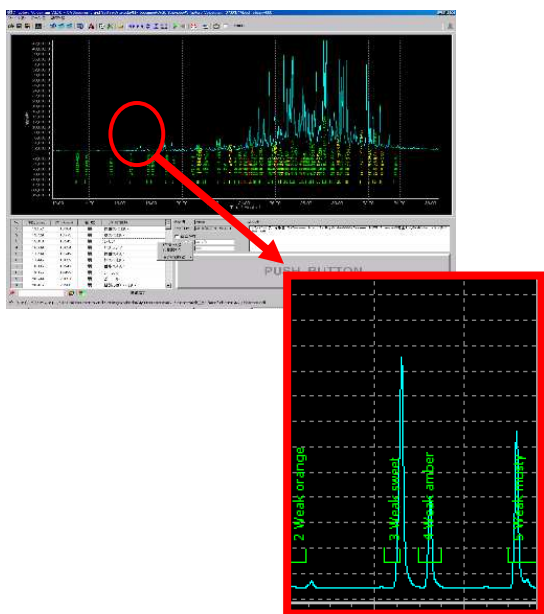

● Aroma pallet

Lemon	Grapefruit	Pineapple	Peach	Banana
Strawberry	Apple	Curry	Caraway	Spicy
Citrus: Citrus	Rose	Floral, Sweet	Floral, Bitter	Floral, Spicy
Sweet	Grass	Garlic	Rubber Odors	Excreta
Relax	Fresh	Appetizing	Roasted	Sulfur

Register the characteristics of each odor on Aroma Pallet, and couple it to the chromatogram only by mouse click.

● odor recording function

odor recording function	Windows Vista Business/ Windows 7 Pro	Windows 8.1 Pro/ Windows 10 Pro
Voice input	●	×
Voice recording	●	●
Aroma pallet	●	●

Specification

Recommended OS	Windows 10 Pro (all 32,64-bit editions)
CPU / memory	Recommended by OS
Communications port	1x RS-232C Port (use of a USB serial converter is possible)
Resolution	1024 × 600 or better

Order Information

PHASER Pro

Description	Cat.No.
Sniffing Port PHASER Pro	2702-18602

Olfactory Voicegram Interface Kit

Description	Cat.No.
Olfactory Voicegram Software Interface Kit	2702-18606

NOTE) PC is not included.

Y- Nose Cone

The Y- Nose Cone does not cover the entire nose, so odor and heat sensations are reduced. This nose cone is used when you need to identify subtle odor components.

NOTE: Conical nose cone is a standard accessory.

- Reducing nasal heat stress
- Improving separation between odors

Description	Cat.No.
Y- Nose Cone	2702-18506



Related Products: MonoTrap

MonoTrap is sorptive media with the large surface area provided by the three dimensional silica monolith's network of through-pores and meso-pores.

- Ready to use without any conditioning
- High efficient adsorption
- Flexible ways of sampling
- Abundant series line-up



Rod shape

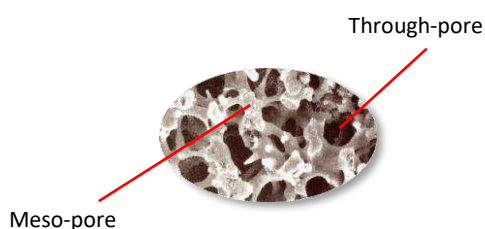

	Description	Operating Temp.	Appearance	Shape	Size	Adsorbent and Stationary Phase				Qty.	Cat.No.
						Active Carbon	Graphite Carbon	ODS Function	PDMS		
Solvent Extraction	MonoTrap DCC18	—		Disk	O.D. 10 mm Thickness 1 mm	●		●		50	1050-72101
	MonoTrap RCC18	—		Rod	O.D. 2.9 mm Len. 5 mm	●		●			1050-72201
	MonoTrap DSC18	—		Disk	O.D. 10 mm Thickness 1 mm			●			1050-71101
	MonoTrap RSC18	—		Rod	O.D. 2.9 mm Len. 5 mm			●			1050-71201
Thermal Desorption	MonoTrap RGC18 TD	200 °C		Rod	O.D. 2.9 mm Len. 10 mm		●	●		30	1050-74201
	MonoTrap RSC18 TD	200 °C						●			1050-73201
	MonoTrap RGPS TD	250 °C				●		●			1050-74202

Note: MonoTrap for Thermal Desorption is packed individually in an ampoule.

Related Products: Capillary Column

InertCap® Pure-WAX

Your First Choice for GC/O

InertCap Pure-WAX is a highly polar column incorporating polyethyleneglycol. With newly developed treatment technology, InertCap Pure-WAX allows to realize the highest inertness among the available columns. InertCap Pure-WAX is an optimal column for analyses of acidic and/or basic compounds, that using existing WAX columns can not be analyzed.



- Polyethylene Glycol (PEG)
- Equivalent to USP Phase G16
- High-polar Column
- Chemical Bond: Cross-Link
- For Polar Compounds and Isomers

Structure

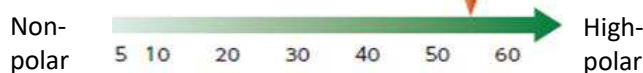
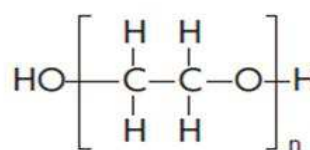

InertCap® Pure-WAX Line-up

I.D. (mm)	Length (m)	Film Thickness (µm)	Max. Temp. (°C)	Cat.No.
0.25	30	0.25	iso.260-prog.260	1010-68142
		0.50	iso.260-prog.260	1010-68144
	60	0.25	iso.260-prog.260	1010-68162
		0.50	iso.260-prog.260	1010-68164
0.32	30	0.25	iso.260-prog.260	1010-68242
		0.50	iso.260-prog.260	1010-68244
	60	0.25	iso.260-prog.260	1010-68262
		0.50	iso.260-prog.260	1010-68264
0.53	15	1.00	iso.240-prog.240	1010-68425
	30	1.00	iso.240-prog.240	1010-68445

Find GC Technical Note:

https://www.glsciences.com/tech/gc_technicalnote/

<https://www.glsciences.eu>



GL Sciences disclaims any and all responsibility for any injury or damage which may be caused by this data directly or indirectly. We reserve the right to amend this information or data at any time and without any prior announcement.

GL Sciences, Inc. Japan

22-1 Nishishinjuku 6-Chome
Shinjuku-ku, Tokyo,
163-1130, Japan
Phone: +81-3-5323-6620
Fax: +81-3-5323-6621
Email: world@glsc.co.jp
Web: www.glsciences.com

GL Sciences B.V.

Dillenburgstraat 7C
5652 AM Eindhoven
The Netherlands
Phone: +31 (0)40 254 95 31
Email: info@glsciences.eu
Web: www.glsciences.eu

GL Sciences (ShangHai) Ltd.

Tower B, Room 2003,
Far East International Plaza,
NO,317 Xianxia Road,
Changning District.
Shanghai, China P.C. 200051
Phone: +86 (0)21-6278-2272
Email: contact@glsciences.com.cn
Web: www.glsciences.com.cn

GL Sciences, Inc. USA

4733 Torrance Blvd. Suite 255
Torrance, CA 90503
Phone: 310-265-4424
Fax: 310-265-4425
Email: info@glsciencesinc.com
Web: www.glsciencesinc.com

International Distributors

Visit our Website at:

<https://www.glsciences.com/company/distributor.html>